



S1-S

Kit Solar 6 en 1 Modelo: K-555

Manual de Instrucciones
V0909



Kit Solar 6 en 1

K-555

Gracias

por la compra de este producto Steren. Antes de empezar a utilizar su nuevo kit solar, por favor lea completo este manual.

Para apoyo, compras y para todo lo nuevo que tiene Steren, visite nuestro sitio Web en:
www.steren.com

Importante

Antes de utilizar su nuevo kit solar, por favor lea las siguientes recomendaciones

- Se recomienda su uso para niños mayores a 10 años.
- Se recomienda la supervisión de un adulto.
- Mantenga alejados a los niños menores a 3 años. El kit contiene piezas pequeñas que pueden dañarlos.

Información

Este kit solar es perfecto para principiantes, ya que aplica los principios básicos de la energía solar. Consta de partes de plástico, un módulo solar y un motor que son suficientes para armar seis modelos diferentes.



Herramientas necesarias:

Alicates

Piezas mecánicas:

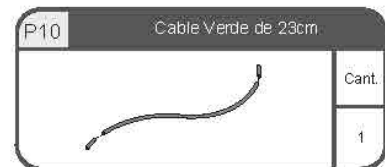
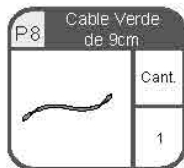
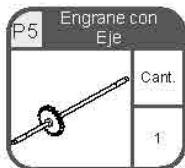
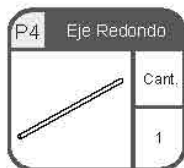
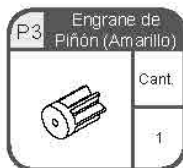
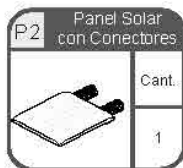
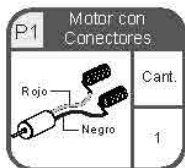

Piezas de plástico:

A

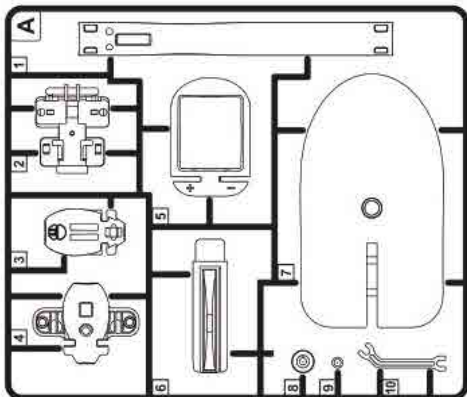

B

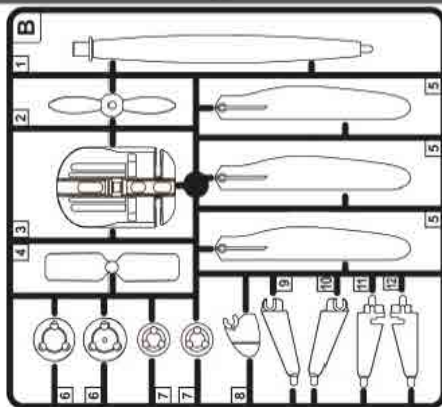

Ensamblado del motor:

Partes Requeridas



P1



P3



P5



A9



A8



A3



A4

Paso

1

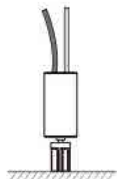
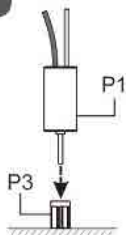

Paso

2

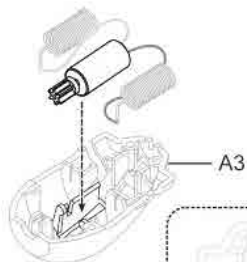

Paso

3

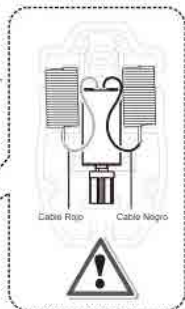
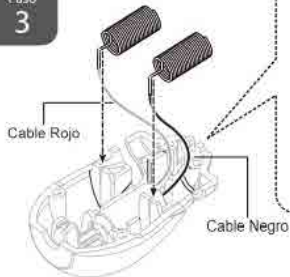

Paso
4

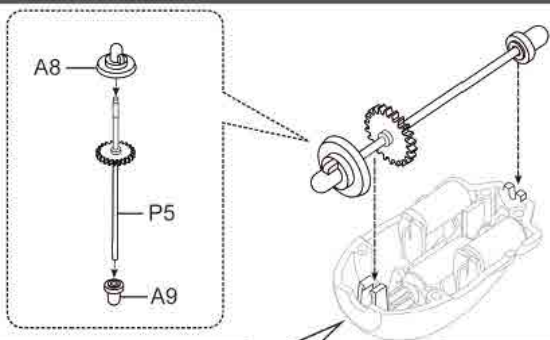

Paso
5

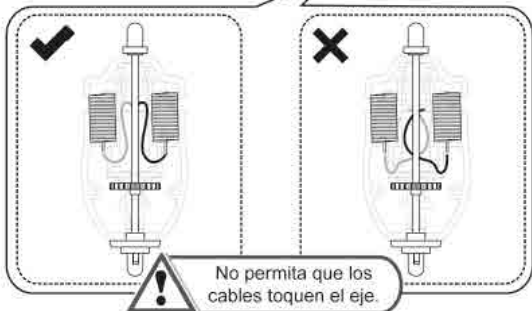

Paso
6

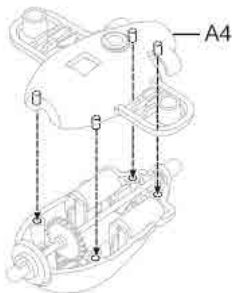

Paso
7

Motor Terminado

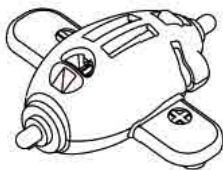

Ensamblado del Módulo Solar:

Partes requeridas



P2



P6x2



A5



B3

Paso

1

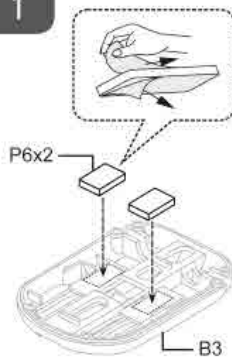

Paso

2

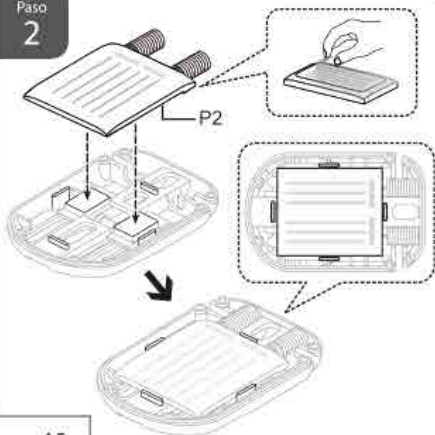

Paso

3

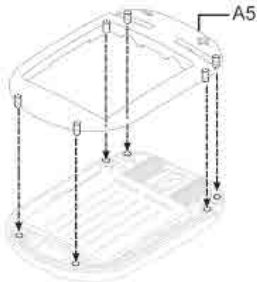

Paso

4

Panel Terminado



Como hacer funcionar el motor:

Partes Requeridas



Módulo Solar

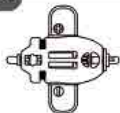

Motor



P9



P10

Paso
1

Enrollar la punta
de los cables:

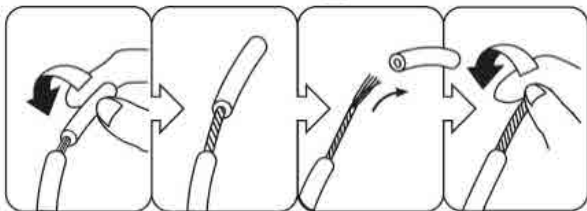
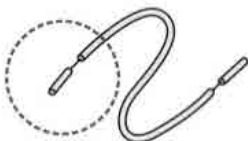

Paso
2

P9

P10

P7

P8

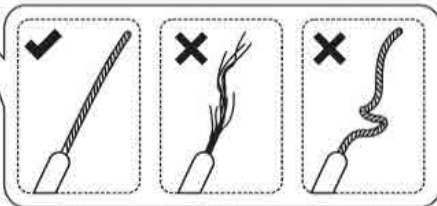

Paso
3

Módulo Solar Conectar a: Motor

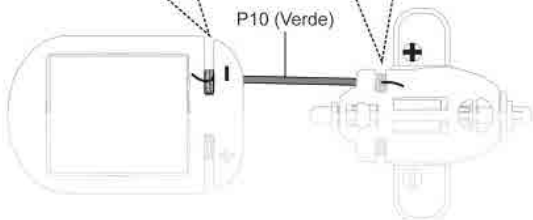
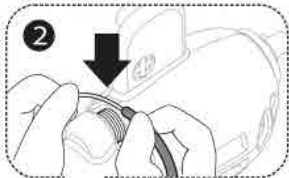
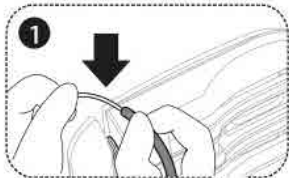

Paso
4

Módulo Solar Conectar a: Motor

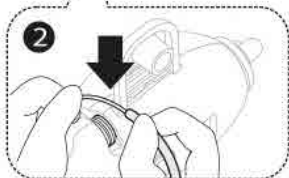
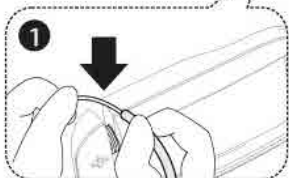
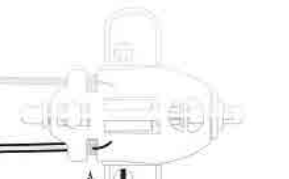

Paso
5

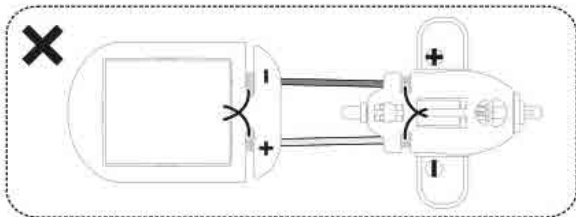
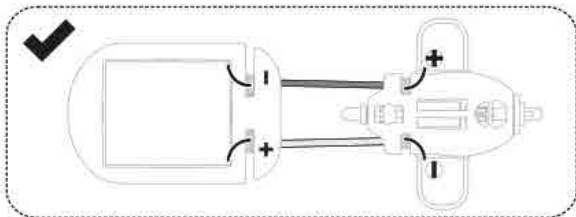

No permita que las puntas de los cables se toquen.

Paso
6

Producto Terminado

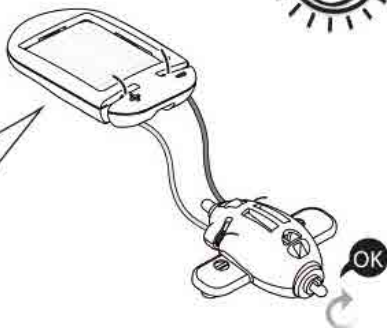
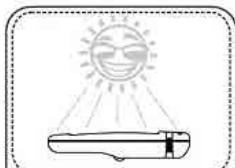

Molino de viento solar

Partes requeridas



Módulo Solar

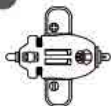

Motor



P9



P10



B6



B5x3



A10



B1



A7

Paso

1

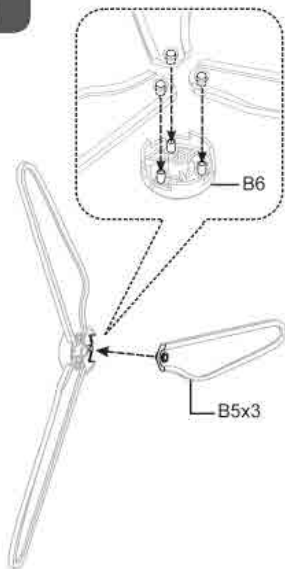

Paso

2

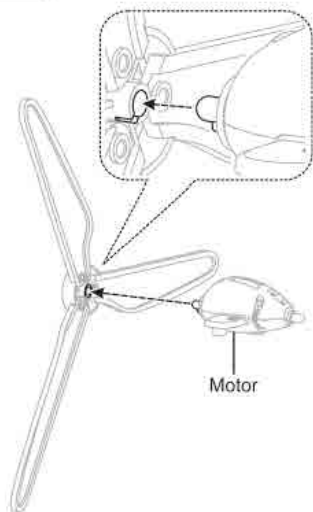

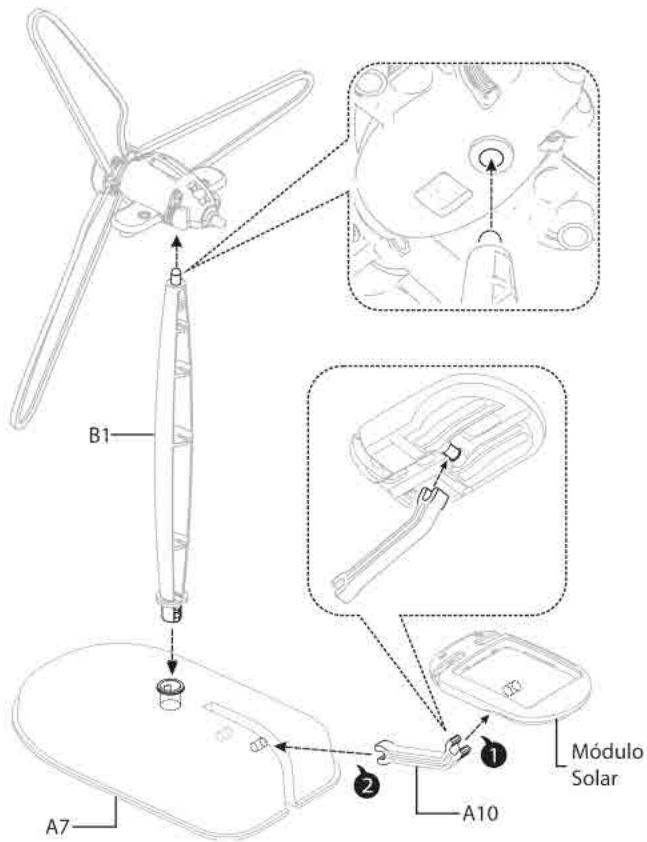

Paso
4

Módulo
Solar

Conectar
a:

+

Motor

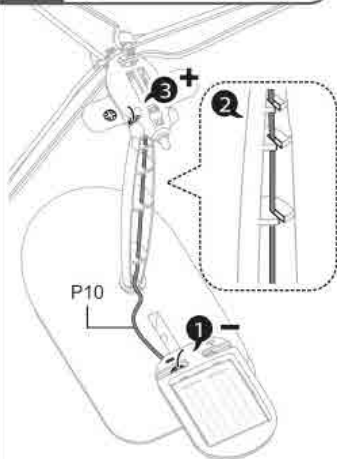

Paso
5

Módulo
Solar

Conectar
a:

-

Motor

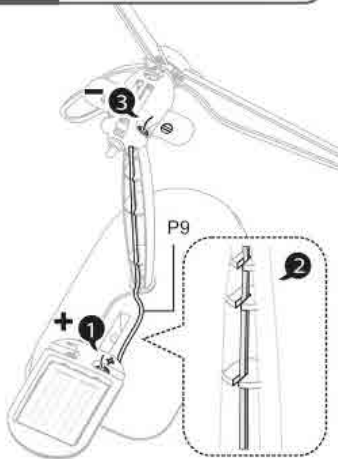

Paso
6

Producto Terminado

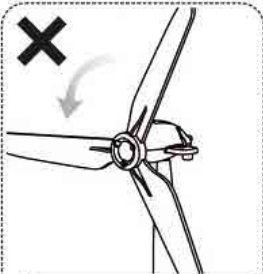
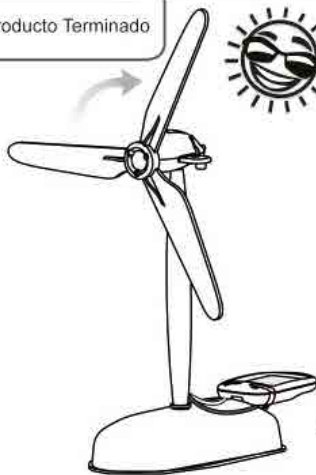

Si el molino gira en la dirección incorrecta, revise los pasos 4 y 5

Avión solar

Partes Requeridas



Módulo Solar



Motor



P7



P8

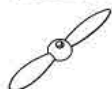

B2



B9



B8



A10



A7

Paso
1

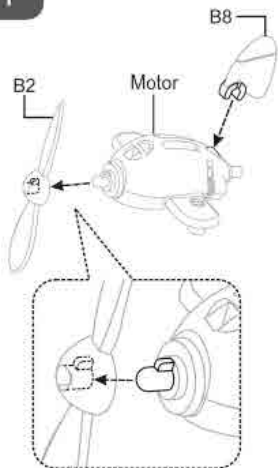

Paso
2

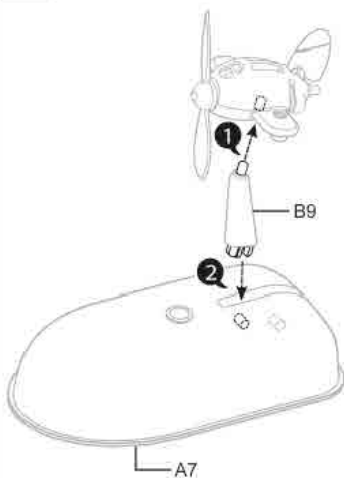

Paso
3

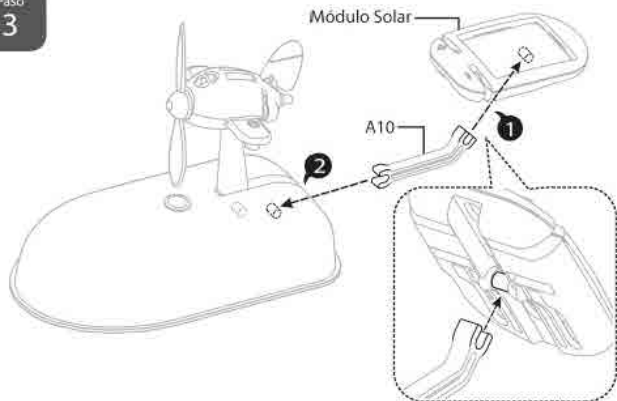

Paso
4

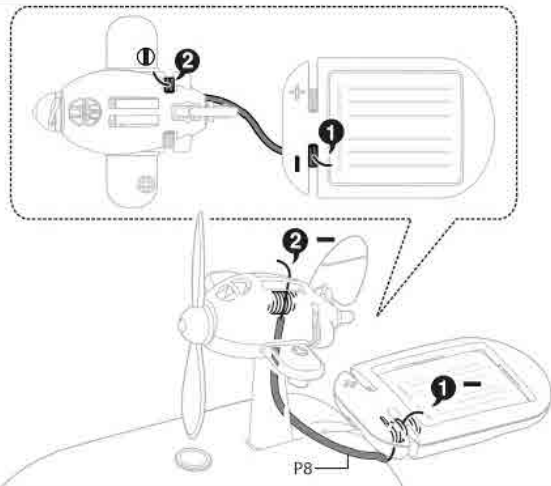

Paso
5

Módulo
Solar



Conectar
a:



Motor

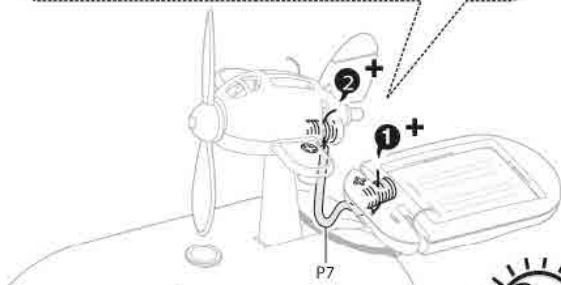
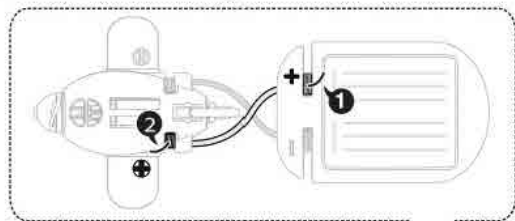

Paso
6

Avión Terminado

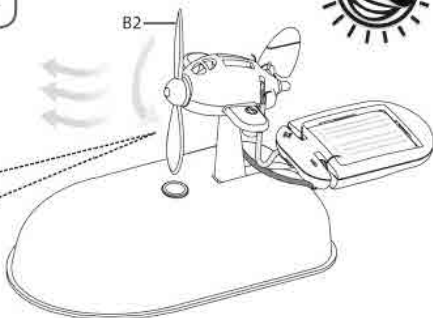

Lancha solar

Partes Requeridas



Módulo Solar



Motor



P7



P8



B4



B9



B11



B12



B8

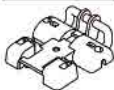

A2



A10



A7

Paso

1

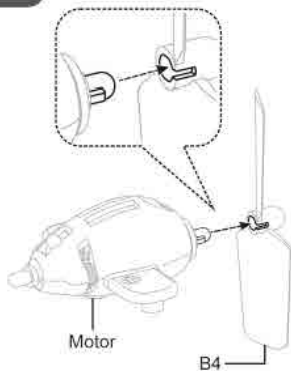

Paso

2

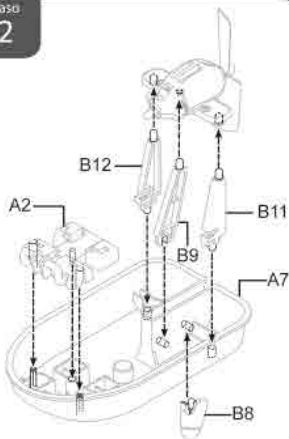

Paso
3

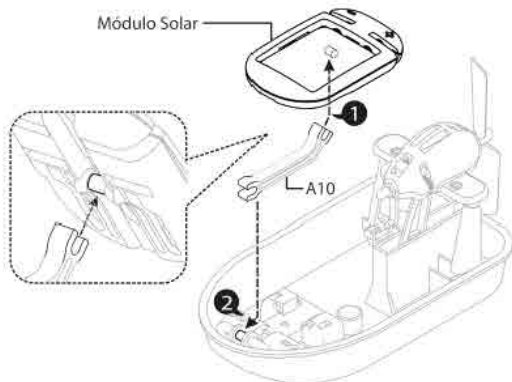

Paso
4

Módulo Solar + Conectar a: + Motor

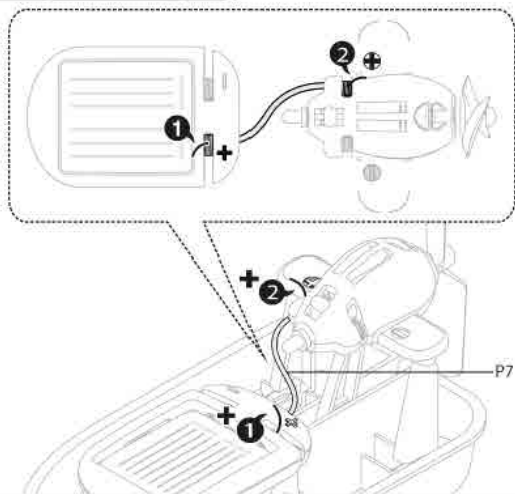

Paso
5

Módulo
Solar

Conectar
a:

Motor

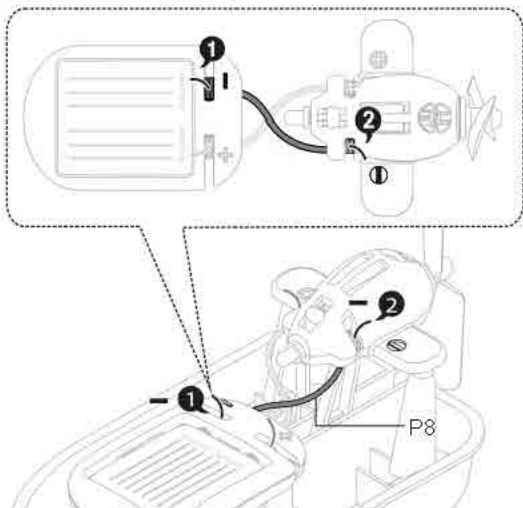

Paso
6

Lancha Terminada

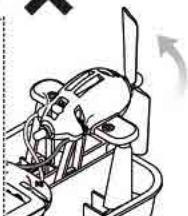

Si el motor gira en
dirección incorrecta, revise
los pasos 4 y 5

Avión solar giratorio

Partes requeridas



Módulo Solar

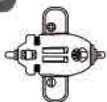

Motor



P9



P10



B2



B8



A10



B1



A7



A6



A1



Moneda
(No incluida)

Paso

1

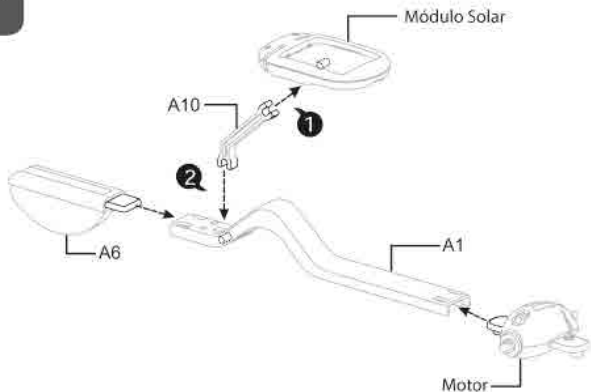

Paso
2

Módulo
Solar -

Conectar
a:

+ Motor

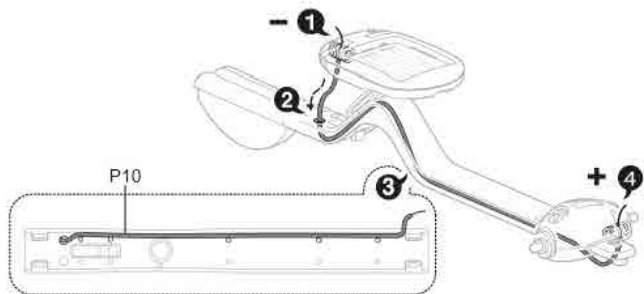

Paso
3

Módulo
Solar +

Conectar
a:

- Motor

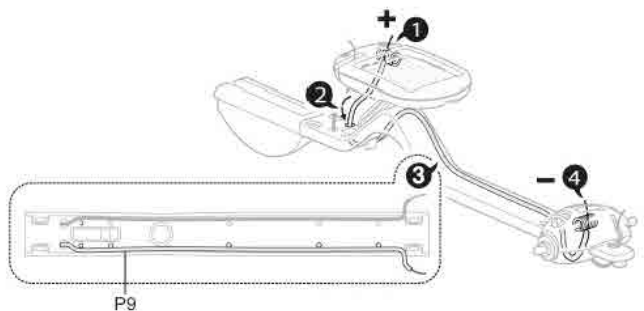

Paso
4

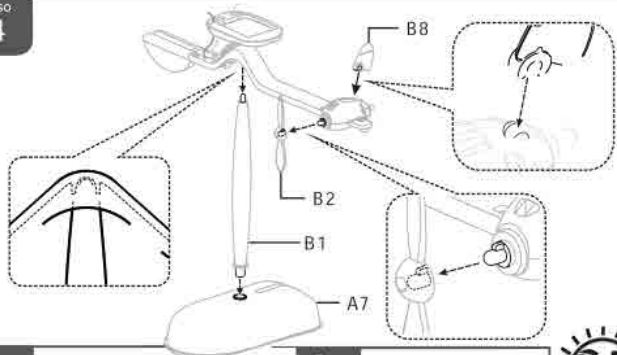

Paso
5

Funcionamiento



(2) Ajuste el módulo solar para balancear el brazo



Paso
6

Avión Terminado

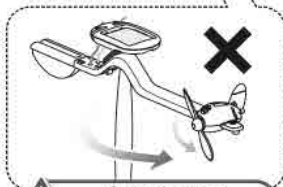

Si el motor gira en
dirección incorrecta, revise
los pasos 2 y 3

Mascota solar

Partes Requeridas



Módulo Solar



Motor



P7



P8



B9



B10



B11



B12



B8



A10



A2

Paso

1

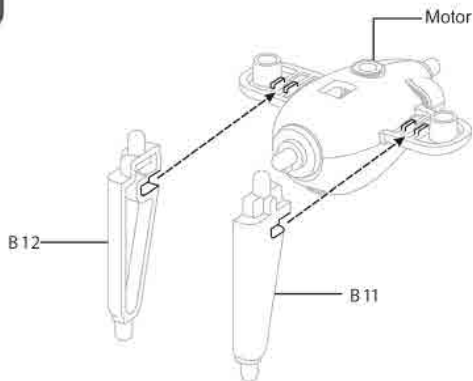

Paso

2

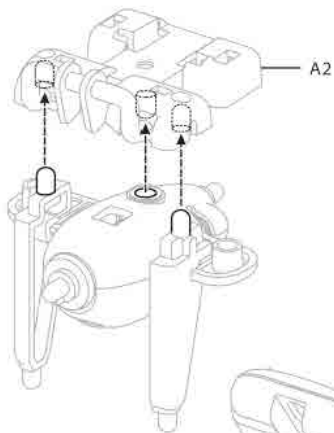

Paso

3

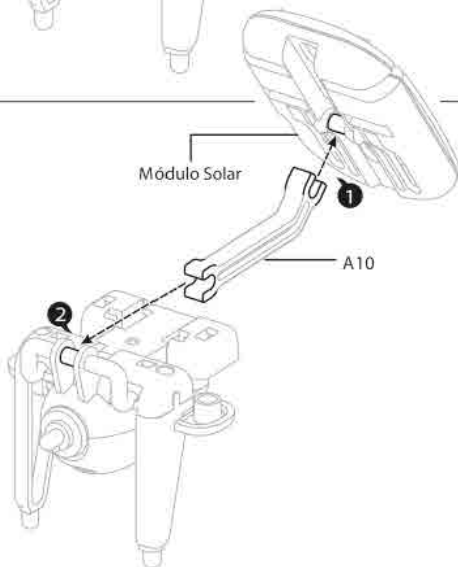

Paso
4

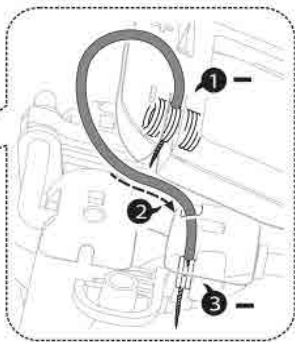
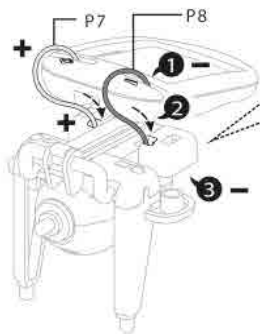
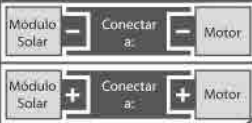

Paso
5

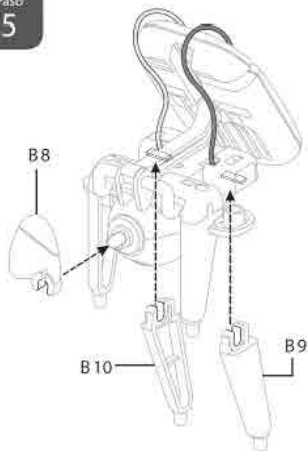

Paso
6

Mascota Terminada



Coche solar

Partes requeridas



Módulo Solar

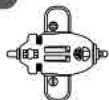

Motor



P7



P8



P4



B7x2



B6x2



A10



A2

Paso

1

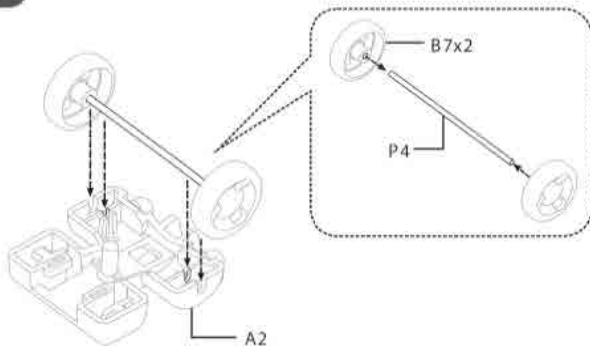

Paso
2

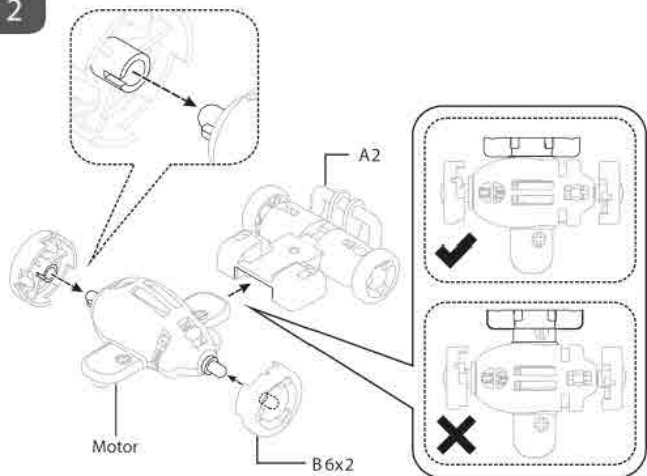

Paso
3

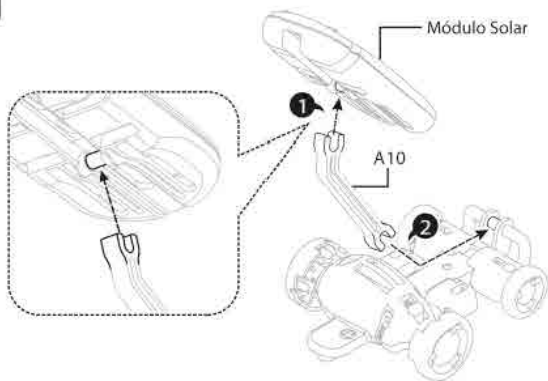

Paso
4

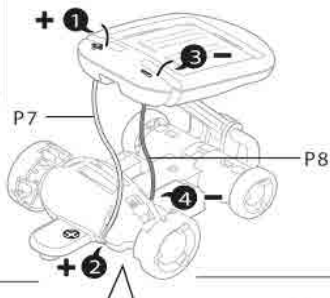
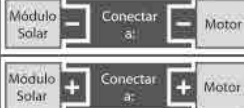

Paso
5

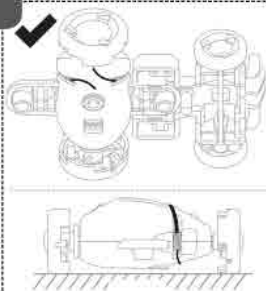

Paso
6

Coche Terminado



Si el coche se mueve en la dirección incorrecta, revise los pasos 4 y 5.

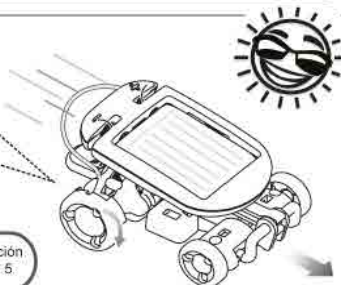

Especificaciones:

Panel solar: 1V $\overline{\text{---}}$ 75mA

Motor: 12000 rpm / 1,2V $\overline{\text{---}}$

Importante:

**El diseño del producto y las especificaciones pueden cambiar sin
previo aviso**



STEREN®

Producto: Kit solar 6 en 1

Modelo: K-555

Marca: Steren

PÓLIZA DE GARANTÍA

Esta póliza garantiza el producto por el término de un año en todas sus partes y mano de obra, contra cualquier defecto de fabricación y funcionamiento, a partir de la fecha de entrega.

CONDICIONES

- 1.- Para hacer efectiva la garantía, presente ésta póliza y el producto, en donde fue adquirido o en Electrónica Steren S.A. de C.V.
- 2.- Electrónica Steren S.A. de C.V. se compromete a reparar el producto en caso de estar defectuoso sin ningún cargo al consumidor. Los gastos de transportación serán cubiertos por el proveedor.
- 3.- El tiempo de reparación en ningún caso será mayor a 30 días, contados a partir de la recepción del producto en cualquiera de los sitios donde pueda hacerse efectiva la garantía.
- 4.- El lugar donde puede adquirir partes, componentes, consumibles y accesorios, así como hacer válida esta garantía es en cualquiera de las direcciones mencionadas posteriormente.

ESTA PÓLIZA NO SE HARÁ EFECTIVA EN LOS SIGUIENTES CASOS:

- 1.- Cuando el producto ha sido utilizado en condiciones distintas a las normales.
- 2.- Cuando el producto no ha sido operado de acuerdo con el instructivo de uso.
- 3.- Cuando el producto ha sido alterado o reparado por personal no autorizado por Electrónica Steren S.A. de C.V. El consumidor podrá solicitar que se haga efectiva la garantía ante la propia casa comercial donde adquirió el producto. Si la presente garantía se extraviara, el consumidor puede recurrir a su proveedor para que le expida otra póliza de garantía, previa presentación de la nota de compra o factura respectiva.

DATOS DEL DISTRIBUIDOR

Nombre del Distribuidor _____

Domicilio _____

Número de serie _____

Fecha de entrega _____

En caso de que su producto presente alguna falla, acuda al centro de distribución más cercano a su domicilio y en caso de tener alguna duda o pregunta por favor llame a nuestro Centro de Atención a Clientes, en donde con gusto le atenderemos en todo lo relacionado con su producto Steren.

Centro de Atención a Clientes
01 800 500 9000

ELECTRONICA STEREN S.A. DE C.V.

Camarones 112, Obrero Popular, 02840, México, D.F.
RFC: EST850629-K51

STEREN PRODUCTO EMPACADO S.A. DE C.V.

Biólogo Maximino Martínez No. 3408 Int. 3 y 4, San Salvador Xochimilcan,
México, D.F. 02670, RFC: SPE941215H43

ELECTRONICA STEREN DEL CENTRO, S.A. DE C.V.

Rep. del Salvador 20 A y B, Centro, 06000, México, D.F.
RFC: ESC9610259N4

ELECTRONICA STEREN DE GUADALAJARA, S.A.

López Cotilla No. 51, Centro, 44100, Guadalajara, Jal.
RFC: ESG810511HT6

ELECTRONICA STEREN DE MONTERREY, S.A.

STEREN DE TIJUANA, S.A. de C.V. Calle 2a, Juárez 7636, Centro, 22000,
Tijuana, B.C.N.
RFC: EST980909NUS



S1-S

6 in 1 Solar Kit

Part number: K-555

Instruction Manual
V0909



6 in 1 solar kit

K-555

Thank you

for purchasing your new Steren product. Before using these Solar Kit, please read this manual completely.

For support, shopping, and everything new at Steren, visit our website:

www.steren.com

Important

Before using your new solar kit, please read next recommendations

- Recommended for kids older than 10 years
- Adult supervision is recommended
- Keep children under 3 y.o. away while assemble this kit. This kit includes small pieces and may cause choking hazards.

Introduction

This solar kit is perfect for beginners, in order to know how solar energy works. It includes all necessary pieces to assemble up to six different models.

Diagonal Cutter



Tools you may need

Long nose pliers

Mechanical parts list

P1 Motor With Springs	
	Qty 1

P2 Solar Panel With Springs	
	Qty 1

P3 Pinion Gear (yellow)	
	Qty 1

P4 Round Shaft	
	Qty 1

P5 Gear With Shaft	
	Qty 1

P6 Adhesive Sponge	
	Qty 2

P7 9cm White Wire	
	Qty 1

P8 9cm Green Wire	
	Qty 1

P9 23cm White Wire	
	Qty 1

P10 23cm Green Wire	
	Qty 1

Plastic parts list:

A

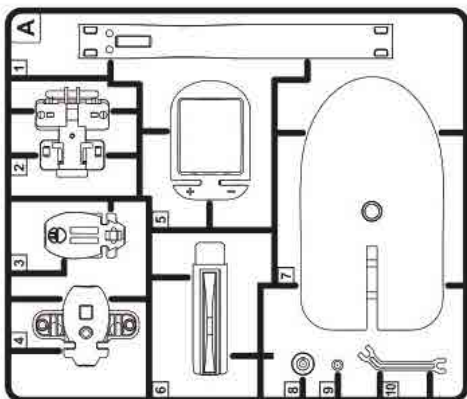

B

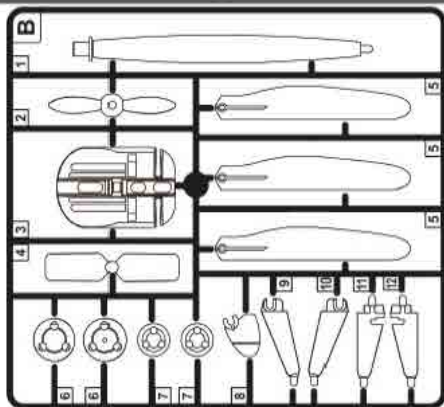

Gear box assembly

Parts Required



P1



P3



P5



A9



A8



A3



A4

STEP
1

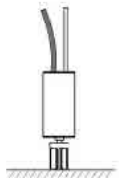
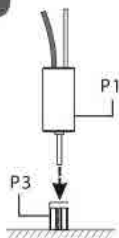

STEP
2

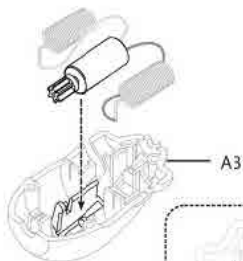

STEP
3

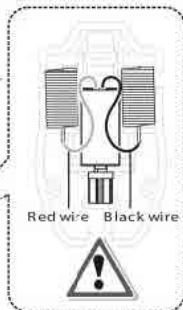
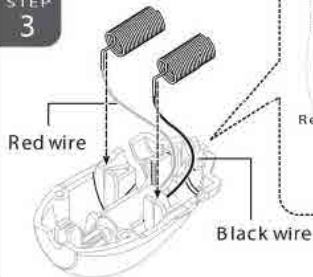

Red wire Black wire

STEP
4

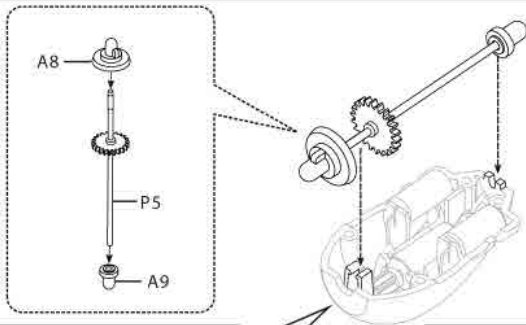

STEP
5

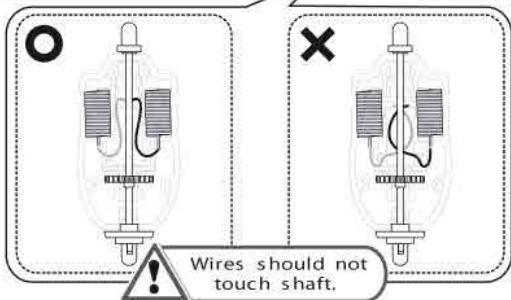

STEP
6

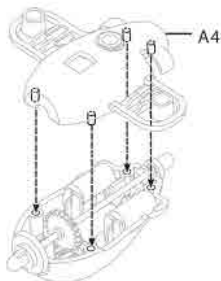

STEP
7

Finished Product!



Solar module assembly

Parts Required



P2



P6x2



A5



B3

STEP 1



P6x2

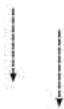

B3

STEP 2



P2

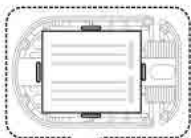

STEP 3

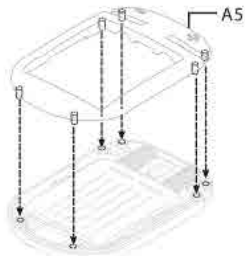

A5

STEP 4

Finished Product!



How to work the gear box

Parts Required



Solar Module



Gear Box



P9



P10

STEP

1

Twist stripped wires:

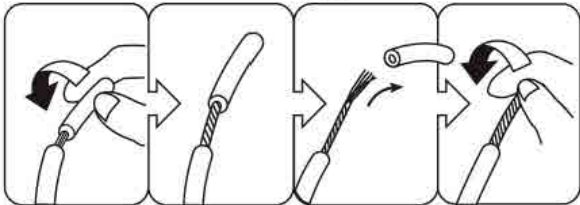
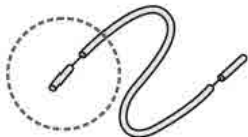

STEP

2

P9

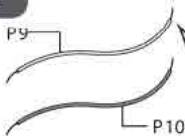

P10

P7

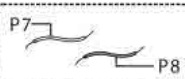

P8

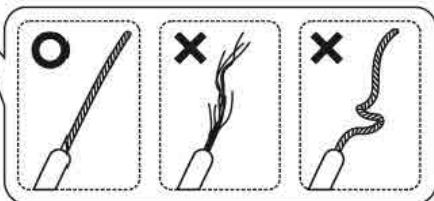

STEP
3

SOLAR MODULE - CONNECT + GEAR BOX

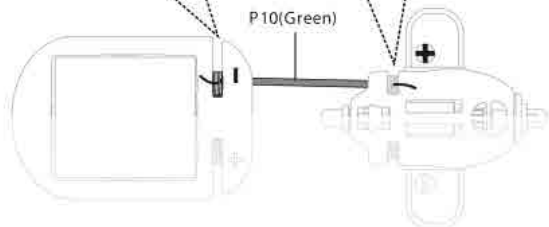
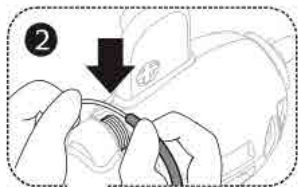
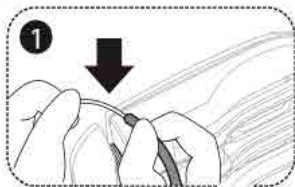

STEP
4

SOLAR MODULE + CONNECT - GEAR BOX

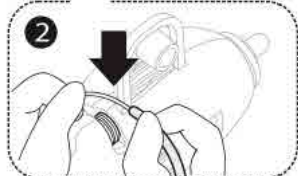
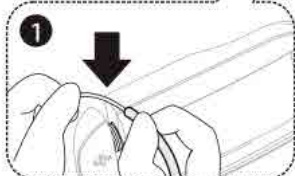
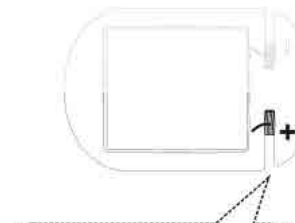

STEP
5

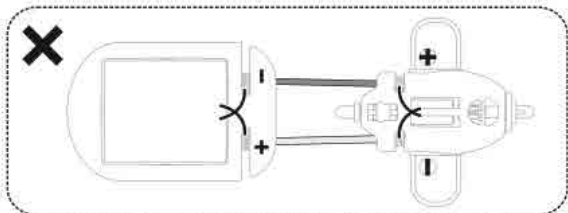
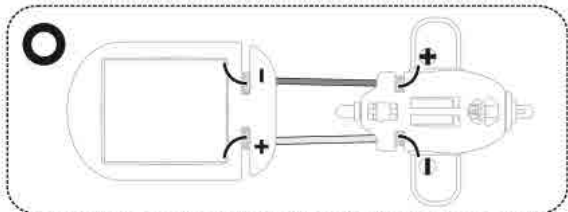

Wires should not touch each other.

STEP
6

Finished Product!

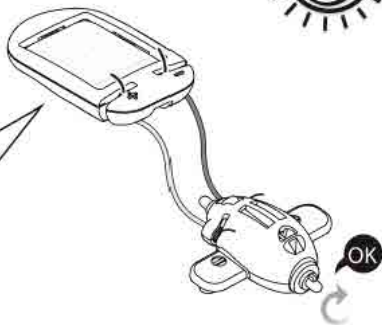
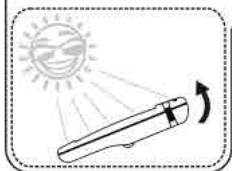
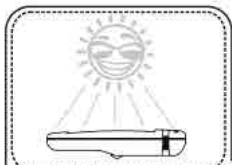

Solar windmill

Parts Required



Solar Module

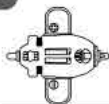

Gear Box

P9

P10



B6



B5x3



A10



B1



A7

STEP
1



STEP
2

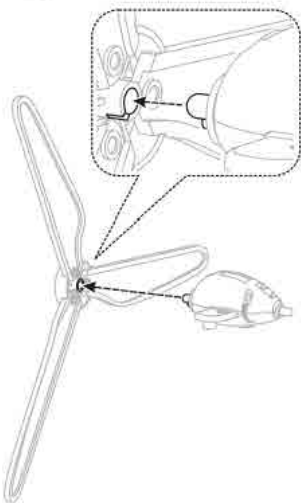

STEP
3

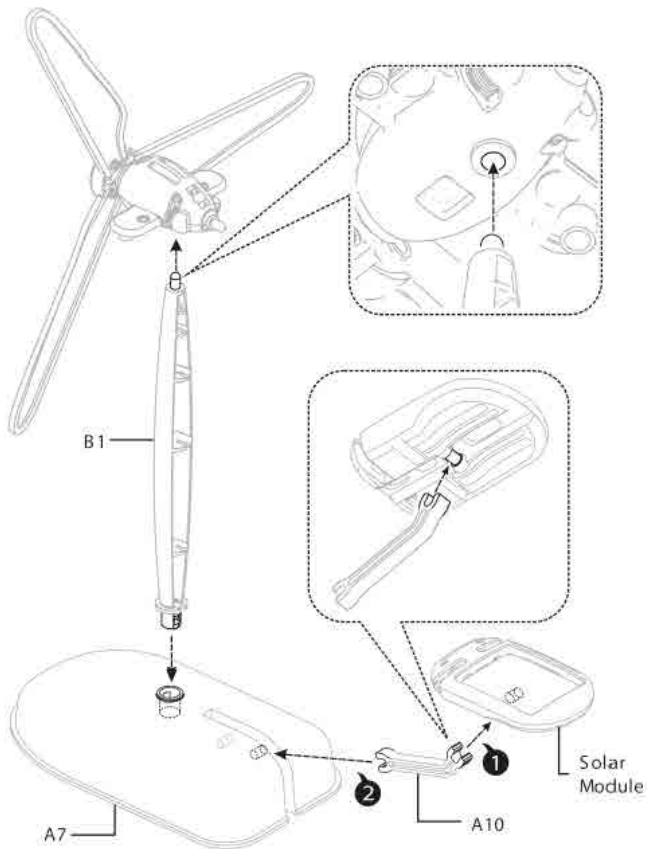

STEP
4

SOLAR
MODULE

CONNECT

GEAR
BOX

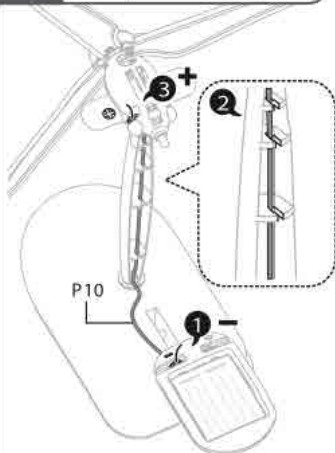

STEP
5

SOLAR
MODULE

CONNECT

GEAR
BOX

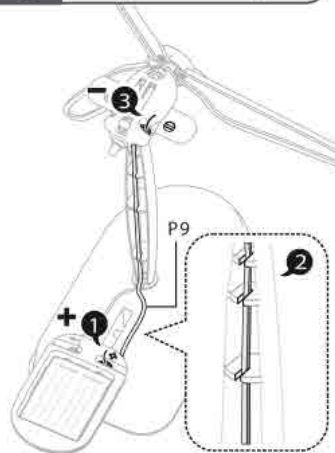

STEP
6

Finished Product!

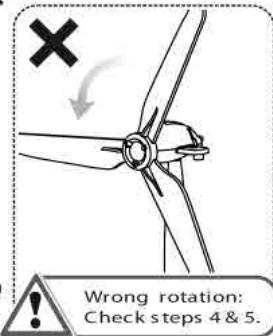
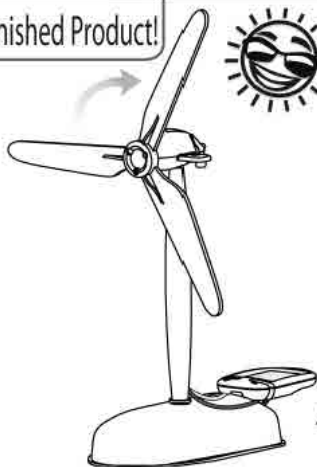

Solar plane

Parts Required



Solar Module

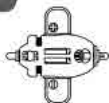

Gear Box



P7



P8

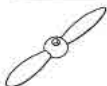

B2



B9



B8



A10



A7

STEP 1

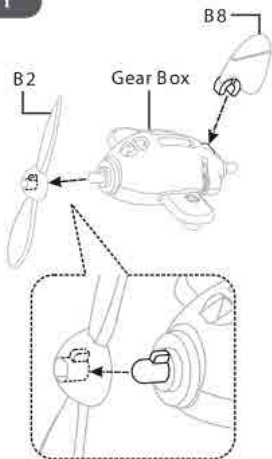

STEP 2

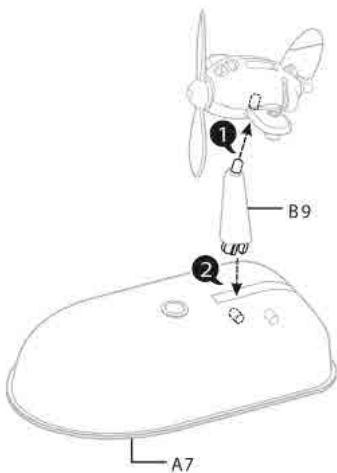

STEP
3

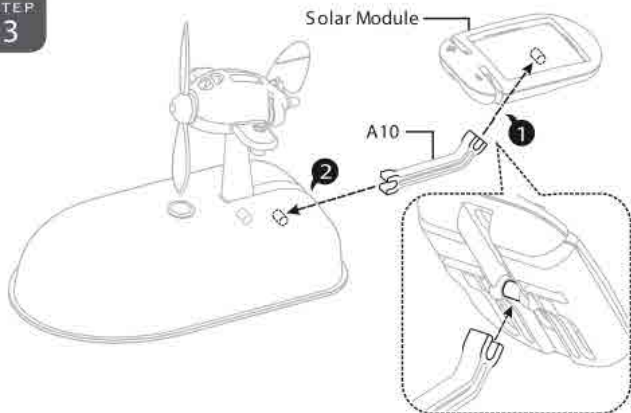

STEP
4

SOLAR
MODULE — CONNECT — GEAR
BOX

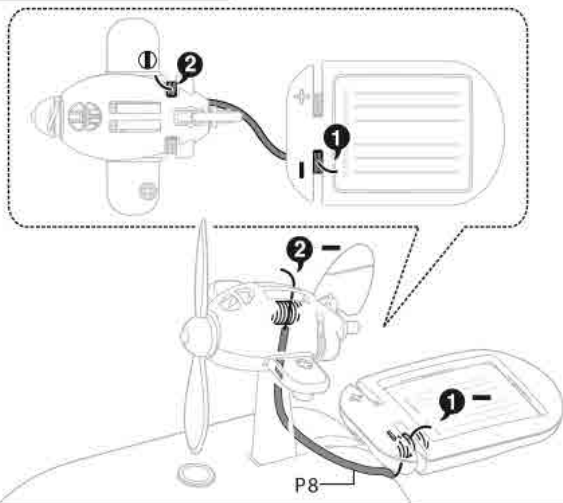

STEP
5

SOLAR
MODULE



CONNECT



GEAR
BOX

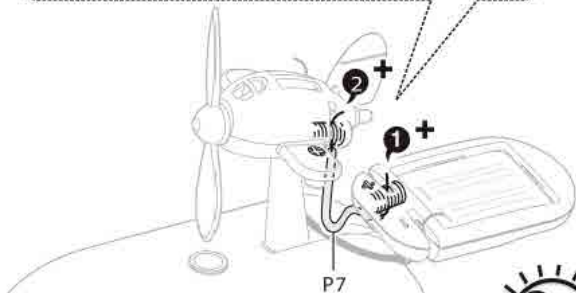
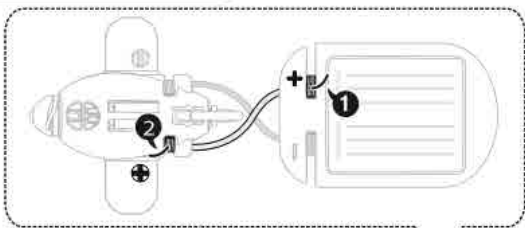

STEP
6

Finished Product!



You may also use
B4 to replace B2.

B4

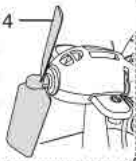

B2

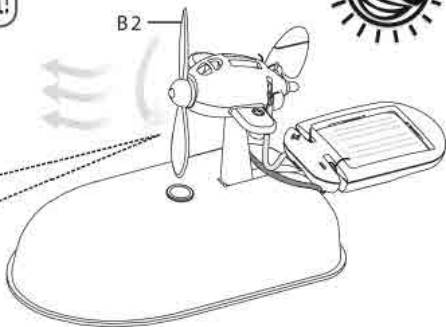

Solar airboat

Parts Required



Solar Module

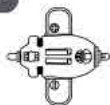

Gear Box



P7



P8



B4



B9



B11



B12



B8



A2



A10



A7

STEP 1

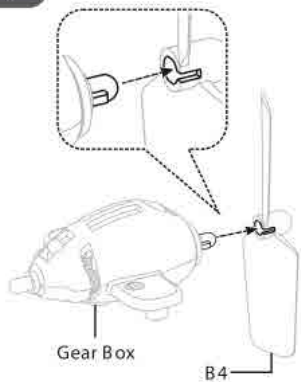

STEP 2

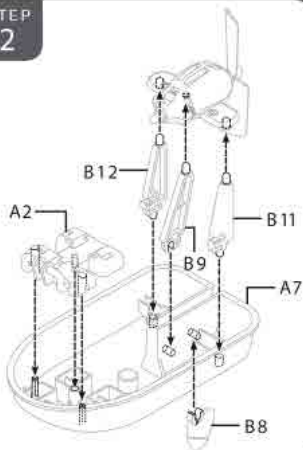

STEP
3

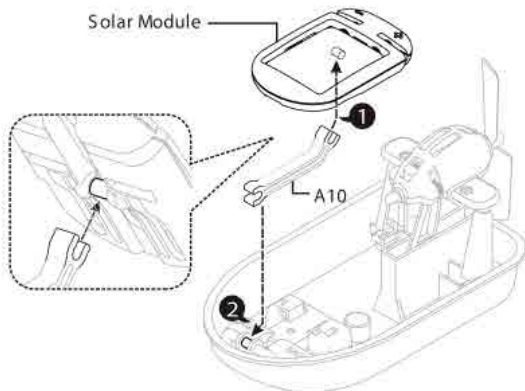

STEP
4

SOLAR MODULE + CONNECT + GEAR BOX

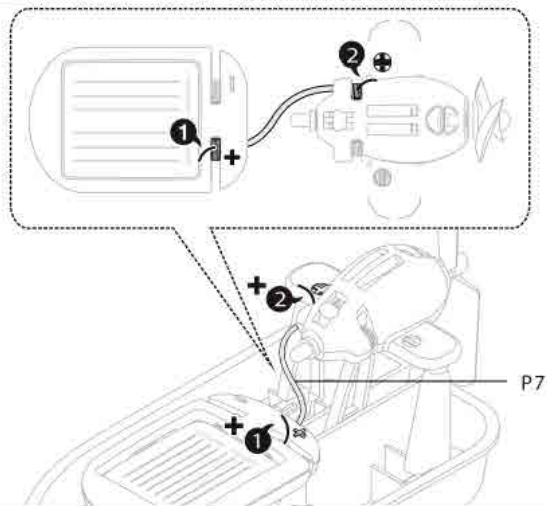

STEP
5

SOLAR
MODULE

CONNECT

GEAR
BOX

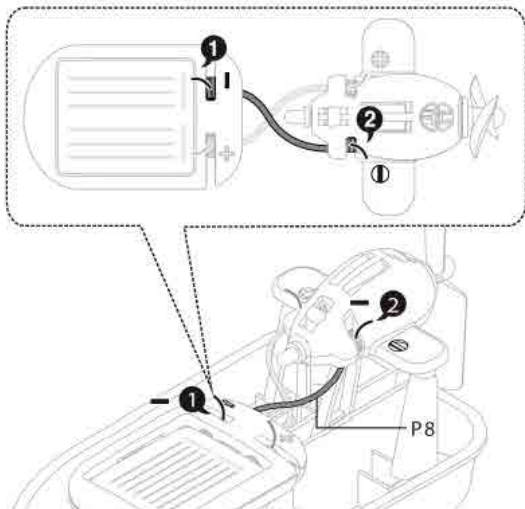

STEP
6

Finished Product!

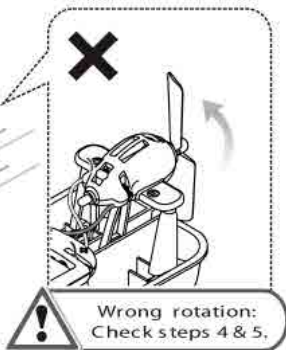

Solar revolving plane

Parts Required



Solar Module

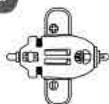

Gear Box



P9



P10

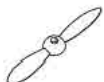

B2



B8



A10



B1



A7



A6



A1



Coin

(Not included)

STEP

1

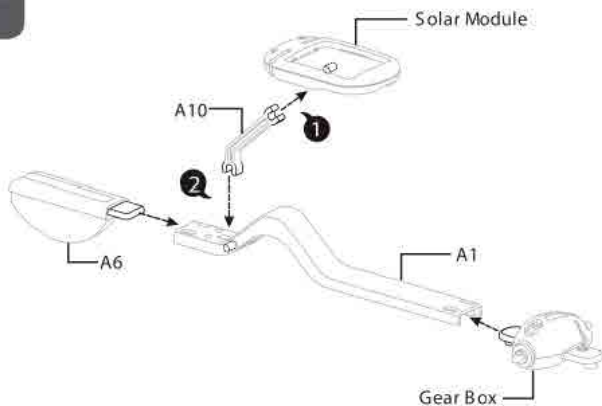

STEP
2

SOLAR
MODULE

CONNECT

GEAR
BOX

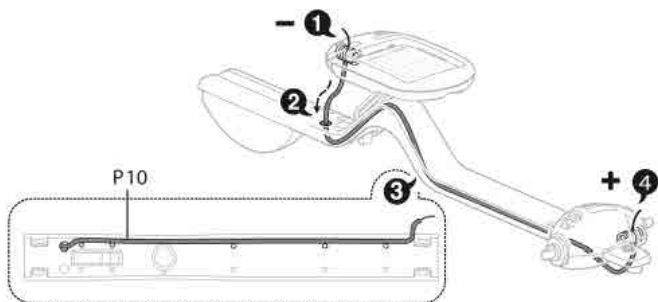

STEP
3

SOLAR
MODULE

CONNECT

GEAR
BOX

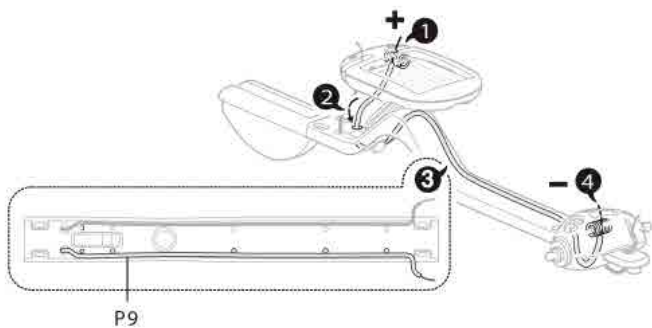

STEP 4

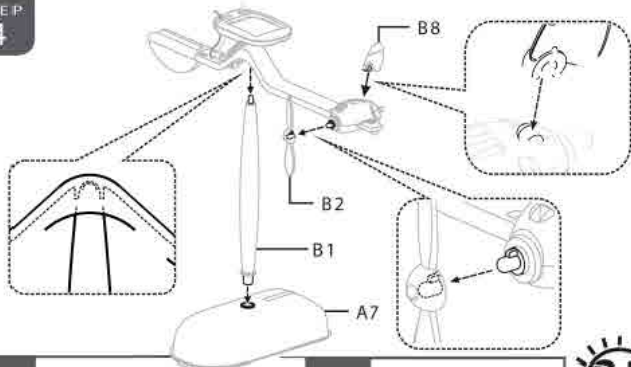

STEP 5 How to play

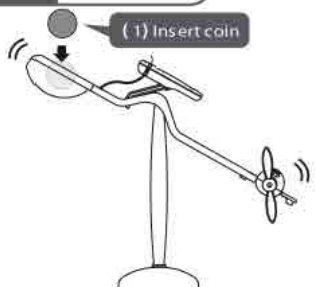

(2) Adjust solar module to balance the lever

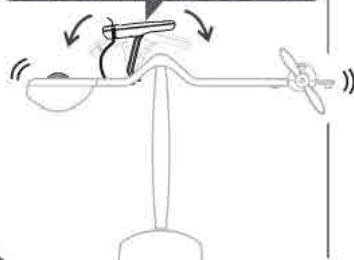

STEP 6 Finished Product!

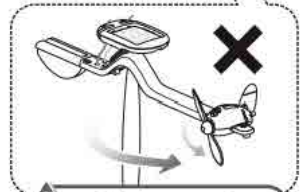

Wrong rotation:
Check steps 2 & 3.

Solar puppy

Parts Required



Solar Module

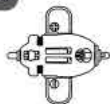

Gear Box



P7



P8



B9



B10



B11



B12



B8



A10

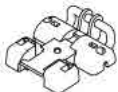

A2

STEP

1

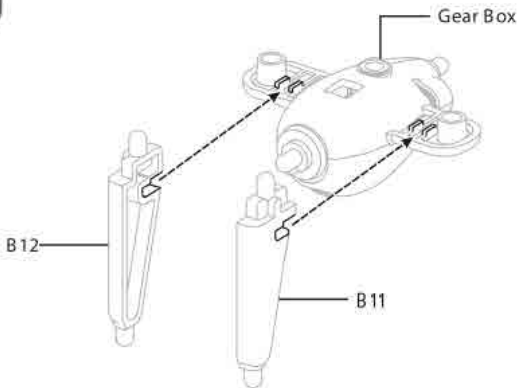

STEP
2

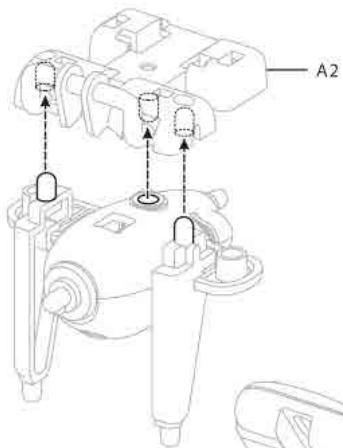

STEP
3

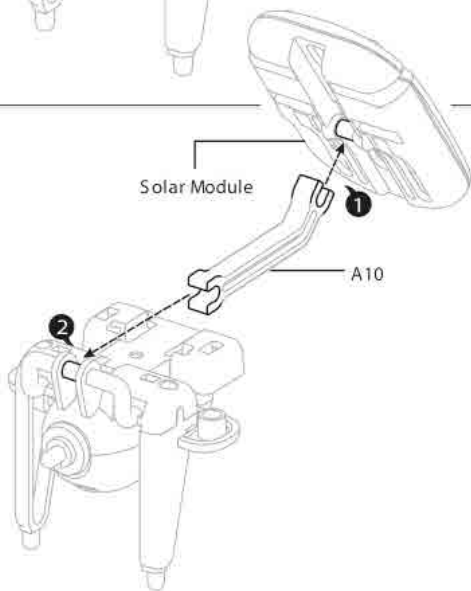

STEP
4

SOLAR MODULE - CONNECT - GEAR BOX

SOLAR MODULE + CONNECT + GEAR BOX

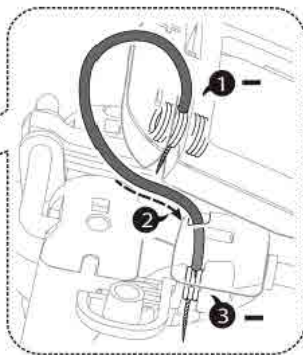
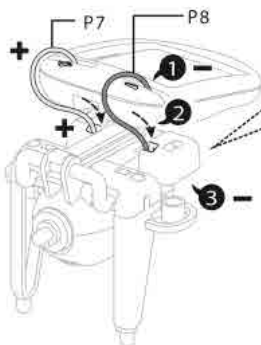

STEP
5

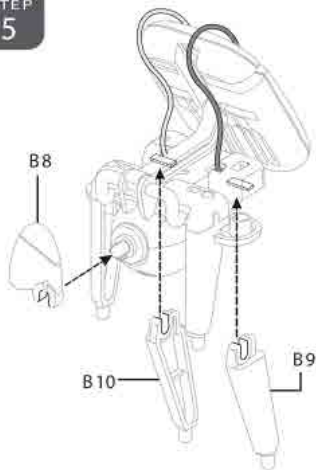

STEP
6

Finished Product!



Solar car

Parts Required



Solar Module

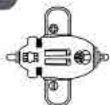

Gear Box



P7



P8



P4



B7x2



B6x2



A10



A2

STEP

1

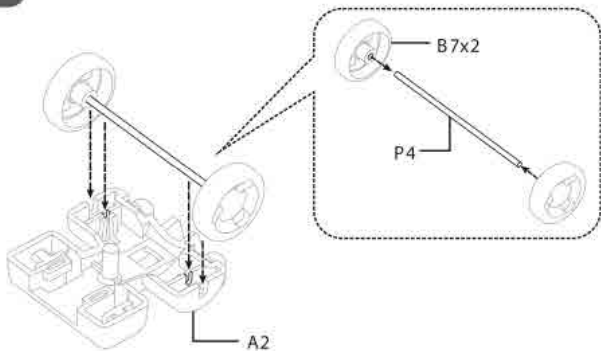

STEP
2

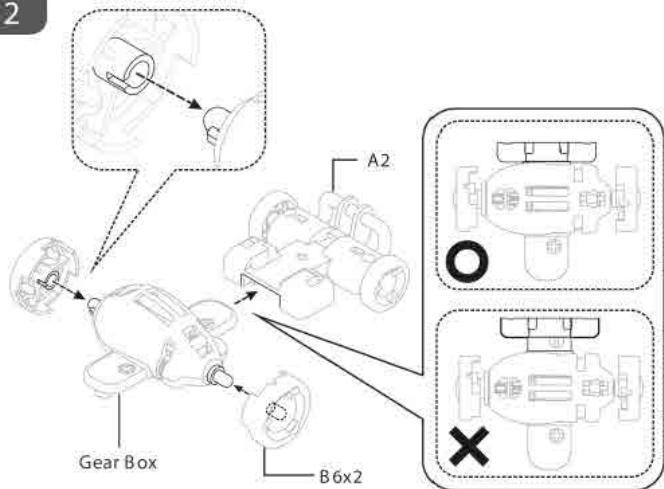

STEP
3

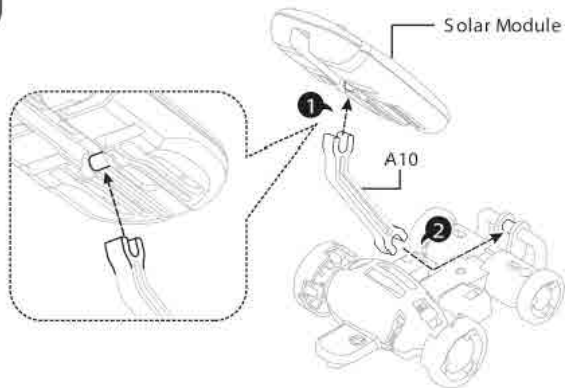

STEP
4

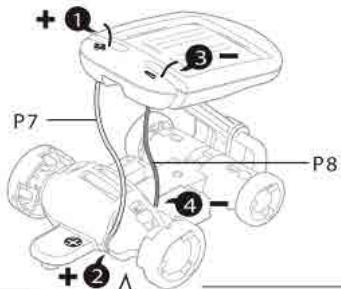
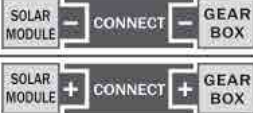

STEP
5

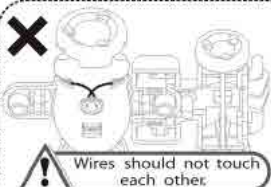
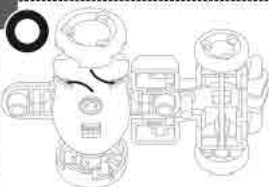

Wires should not touch each other.

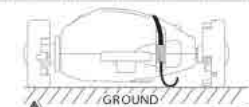

Wires should not touch the ground.

STEP
6

Finished Product!



Wrong motion:
Check steps 4 & 5.



Specifications

Solar panel: 1V \approx 75mA

Motor: 12000 rpm / 1.2V \approx

Important:

Product design and specifications are subject to change without previous notice.



Product: 6 in 1 solar kit

Part number: K-555

Brand: Steren

WARRANTY

This Steren product is warranted under normal usage against defects in workmanship and materials to the original purchaser for one year from the date of purchase.

CONDITIONS

- 1.- This warranty card with all the required information, invoice or purchase ticket, product box or package, and product, must be presented when warranty service is required.
- 2.- If the product stills on the warranty time, the company will repair it free of charge.
- 3.- The repairing time will not exceed 30 natural days, from the day the claim was received.
- 4.- Steren sell parts, components, consumables and accessories to customer, as well as warranty service, at any of the addresses mentioned later.

THIS WARRANTY IS VOID IN THE NEXT CASES:

If the product has been damaged by an accident, acts of God, mishandling, leaky batteries, failure to follow enclosed instructions, improper repair by unauthorized personnel, improper safe keeping, among others.

- a) The consumer can also claim the warranty service in the purchase establishment.
- b) If you lose the warranty card, we can reissue it, if you show the invoice or purchase ticket.